

5429

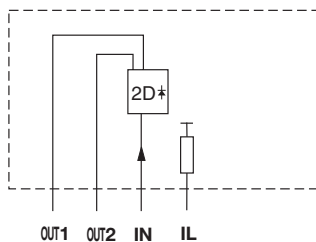

5439

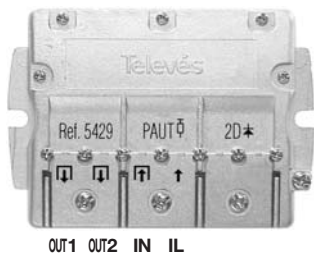
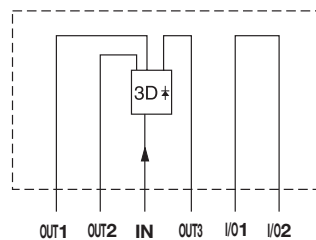
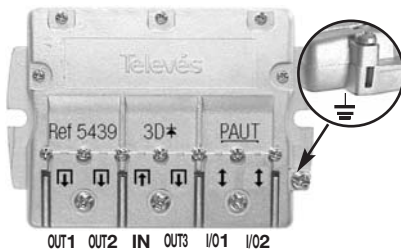

5449

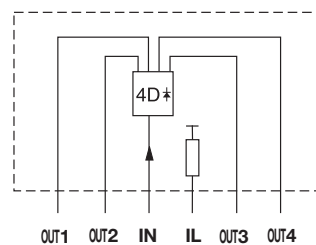
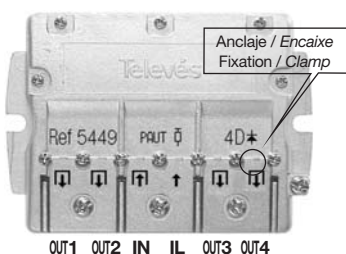

El paso de corriente sólo es posible de las salidas hacia la entrada.  
 A passagem de corrente só é possível das saídas para a entrada.  
 Passage de courant des sorties vers l'entrée exclusivement.  
 The DC pass can only go from the outputs to the input.

Características técnicas		Características técnicas		Spécifications techniques		Technical specifications		
Referencia	Referência	Référence	Reference	5429	5439	5449		
Margen Frec.	Margem freq.	Marge fréq.	Frec. range	5- 2400 MHz				
Atenuación	IN - OUT	(dB)	5 - 47 MHz	3,5	6,5	8		
Atenuação			47 - 862 MHz	4,5	7	7,5		
Atténuation			950 - 2400 MHz	5,5	9	9,5		
Atenuación	IN - OUT3	(dB)	5 - 47 MHz	---	6,5	8		
Atenuação			47 - 862 MHz	---	6,5	7,5		
Atténuation			950 - 2400 MHz	---	7	9,5		
Rechazo entre salidas	(dB)		5 - 862 MHz	> 15	> 15	> 17		
Rejeição entre saídas			950 - 2400 MHz	> 15	> 15	> 15		
Réjéct entre sortie								
Rejection between outputs								
Tensión máx.	Tensão max.	Voltage max.	Max. voltage (V)	40				
Corriente máx.	Corrente max.	Courant max.	Max. current (mA)	(OUT -> IN)	300			

### Accesorios / Acessórios / Accessoires / Accessories



Ref. 5455



Ref. 4087

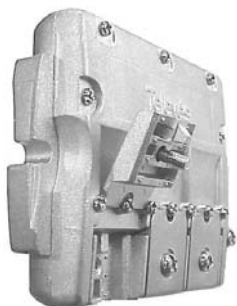

Anclaje de brida para facilitar el conexionado  
Encaixe da braçadeira para facilitar a ligação  
Fixation de la bride pour simplifier la connexion  
Cable clamp joint for easy connection.

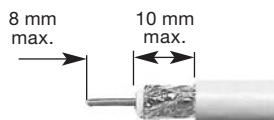

$\text{Ø} < 6,5 \text{ mm}$

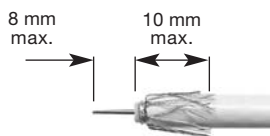

$\text{Ø} > 6,5 \text{ mm}$



Mismo pelado para cables de una misma brida.  
Mesmo descarnado para cabos da mesma braçadeira  
Même découpe du câble par bride  
Same stripping for cables with the same clamp.

Aplicación

Aplicação

Application

Application

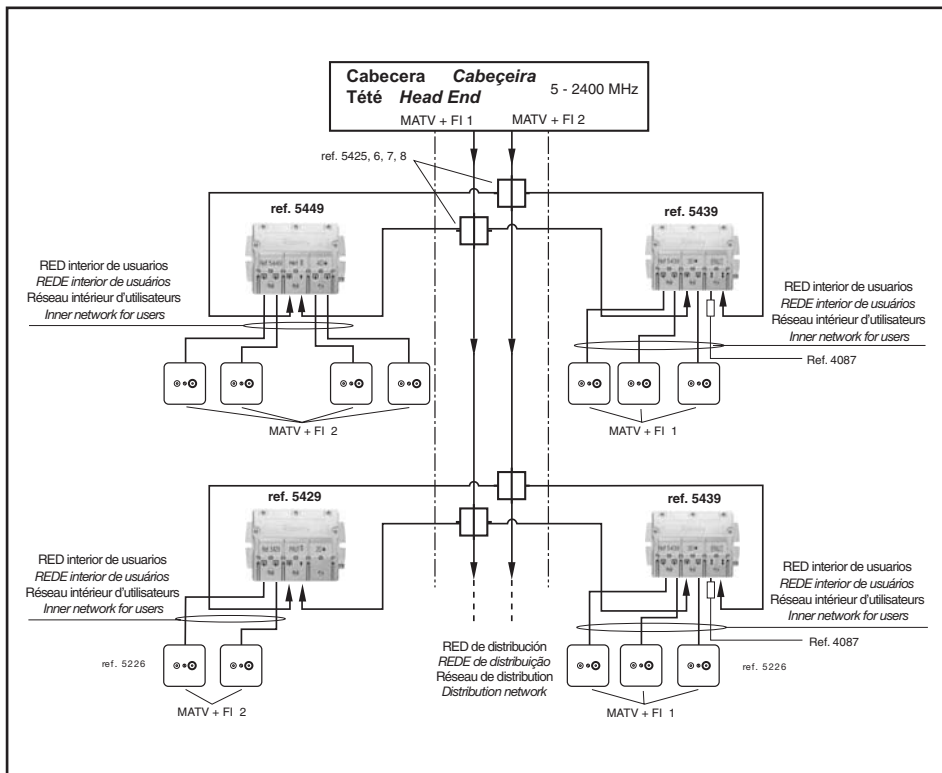

**Televés S.A.** declara bajo su exclusiva responsabilidad la conformidad de éste producto con las Directivas 89/336/CEE y 73/23/CEE.

Puede obtener la Declaración de Conformidad e información complementaria en la página Web:

**Televés S.A.** hereby states, under its own responsibility, that this product is in compliance with the orders of the Directives 89/336/EEC and 73/23/EEC.

You can obtain the Declaration of Conformity and complementary information in the Web page:

<http://www.televes.com>

